

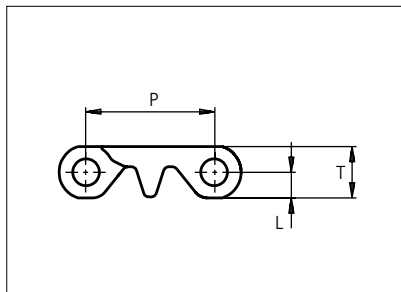

# Plastic Modular Belt

Series **uni S-MPB** Type **C**



Straight running belt  
 Nominal pitch: 25.4 mm (1.00 in)  
 Surface type: Flat  
 Surface opening: Closed  
 Backflex radius: 23.0 mm (0.91 in)  
 Pin diameter: 5.0 mm (0.20 in)

Belt material & color	POM-DI <span style="border: 1px solid black; padding: 0 2px;">W</span>	PP <span style="border: 1px solid black; padding: 0 2px;">W</span>	POM-DI <span style="border: 1px solid black; padding: 0 2px;">B</span>	PP <span style="border: 1px solid black; padding: 0 2px;">B</span>	PE-I <span style="border: 1px solid black; padding: 0 2px;">B</span> <span style="border: 1px solid black; padding: 0 2px;">N</span>	mm	in	T	mm	in
Pin material & color	PP <span style="border: 1px solid black; padding: 0 2px;">W</span>		PP <span style="border: 1px solid black; padding: 0 2px;">B</span>		PE <span style="border: 1px solid black; padding: 0 2px;">N</span>	L	5.2	0.20	-	-

Non standard material and color: See uni Material and Color Overview.

Alternative pin and lock materials: Lockpin: PBT LG PA6.6 N D

Belt width		Permissible tensile force (Belt/pin material)						Belt weight (Belt/pin material)						*Min. No. drive sprocket per shaft	Number of wear strips (Min. No.)	
		POM-DI/PP		PP/PP		PE-I/PP		POM-DI/PP		PP/PP		PE-I/PP			**Carry (pcs)	**Return (pcs)
mm	in	N	lbf	N	lbf	N	lbf	kg/m	lb/ft	kg/m	lb/ft	kg/m	lb/ft			
77	3.0	1810	407	732	164	604	136	0.6	0.43	0.4	0.29	0.4	0.29	2	2	2
153	6.0	3596	808	1454	327	1201	270	1.3	0.85	0.9	0.58	0.9	0.59	2	2	2
184	7.2	4317	971	1745	392	1442	324	1.5	1.02	1.0	0.69	1.0	0.70	2	2	2
229	9.0	5382	1210	2176	489	1798	404	1.9	1.28	1.3	0.86	1.3	0.88	2	2	2
305	12.0	7168	1611	2898	651	2394	538	2.5	1.70	1.7	1.15	1.7	1.17	3	3	2
381	15.0	8954	2013	3620	814	2991	672	3.2	2.13	2.1	1.43	2.2	1.46	3	3	2
457	18.0	10740	2414	4342	976	3588	806	3.8	2.55	2.6	1.72	2.6	1.75	4	4	2
507	20.0	11910	2677	4815	1082	3978	894	4.2	2.83	2.8	1.91	2.9	1.94	4	4	2
533	21.0	12527	2816	5064	1138	4184	941	4.4	2.97	3.0	2.01	3.0	2.04	4	4	2
609	24.0	14313	3218	5786	1301	4781	1075	5.1	3.40	3.4	2.29	3.5	2.33	5	5	3
685	27.0	16100	3619	6508	1463	5378	1209	5.7	3.82	3.8	2.58	3.9	2.62	5	5	3
761	30.0	17886	4021	7231	1625	5975	1343	6.3	4.25	4.3	2.86	4.3	2.92	6	6	3
837	33.0	19673	4422	7953	1788	6571	1477	6.9	4.67	4.7	3.15	4.8	3.21	6	6	3

Additional standard belt widths are available in steps of 76.0 mm (2.99 in). Additional non-standard belt widths are available in steps of 12.7 mm (0.50 in).

1977	77.8	46460	10444	18782	4222	15519	3489	16.4	11.03	11.1	7.44	11.3	7.57	14	14	7
------	------	-------	-------	-------	------	-------	------	------	-------	------	------	------	------	----	----	---

Additional standard belt widths are available in steps of 76.0 mm (2.99 in). Additional non-standard belt widths are available in steps of 12.7 mm (0.50 in).

2965	116.7	69678	15664	28168	6332	23275	5232	24.6	16.54	16.6	11.16	16.9	11.36	20	20	10
------	-------	-------	-------	-------	------	-------	------	------	-------	------	-------	------	-------	----	----	----

General belt tolerance is +0/-0.4% at 23°C/73°F and 50% RH. For exact belt width contact Customer Service. Non standard belt width on request.

\*Max. Load per Drive Sprocket. Belt material: POM-DI 1100 N (247 lbf), PP 500 N (112 lbf), PE 500 N (112 lbf).

\*\*Max. Spacing between wear strips, Carry: 152.0 mm (6.00 in); Return: 304.0 mm (12.00 in).

  = Single Link



STANDARD

STRAIGHT RUNNING

PITCH 25.4 MM/1.00 IN

## Accessories

### Rubber Top

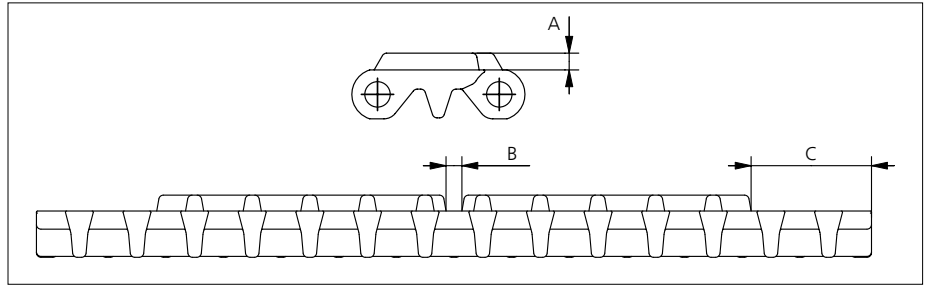

Type	Belt material & color	Rubber material & color	A		B		C		Link size	Width	
			mm	in	mm	in	mm	in		mm	in
Flat	PP <b>B</b>	03 <b>K</b>	3.5	0.14	3.5	0.14	26.5	1.04	K725	184.2	7.25

Non Standard material and color: See uni Material and Color Overview.

## Accessories

### Flight

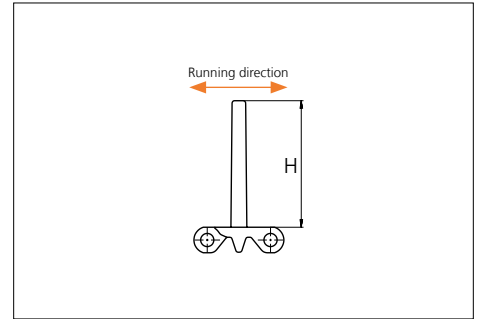
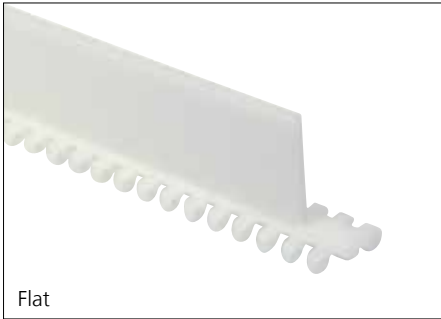

Type	Material & color	H		Link size	Width		Indent both sides	
		mm	in		mm	in	mm	in
13% Non Stick	POM-DI <b>W</b> <b>B</b>	76.2	3.00	K600	151.9	5.98	00.0	0.00
Flat	PP-I <b>W</b> <b>B</b> PE-I <b>N</b> <b>B</b>	50.8	2.00	K2000	506.7	19.95	25.8	1.02

## Accessories

### Side Guard

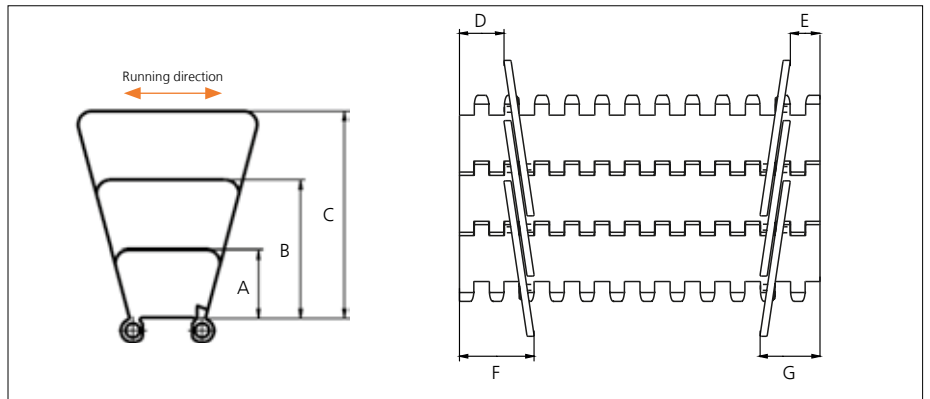

Type	Material & color	A		B		C		D		E		F		G	
		mm	in	mm	in	mm	in	mm	in	mm	in	mm	in	mm	in
Closed	PP-I <b>W</b> <b>B</b>	25.4	1.00	50.8	2.00	76.2	3.00	18.7	0.74	12.5	0.49	31.5	1.24	25.3	1.00

Minimum indent to outside of side guide: 14.0 mm (0.55 in). Increment 6.4 mm (0.25).

Non Standard material and color: See uni Material and Color Overview.

Backflex radius for Side Guide: 75.0 mm (2.95 in).

## Accessories

### Tab

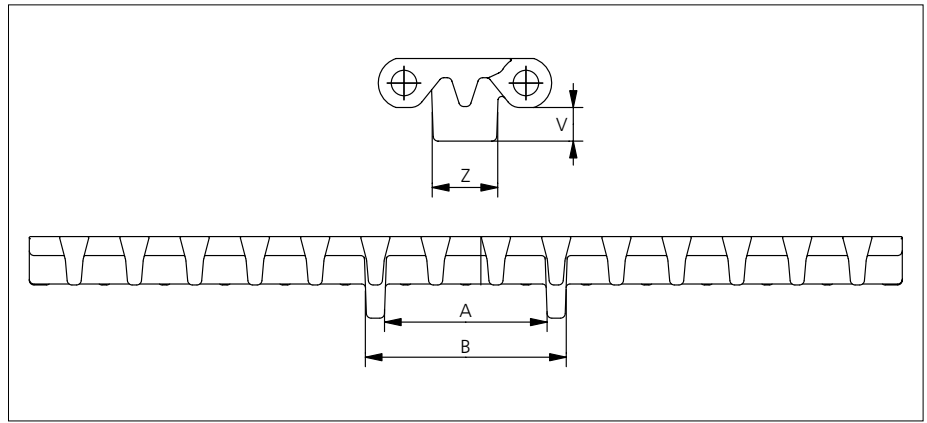
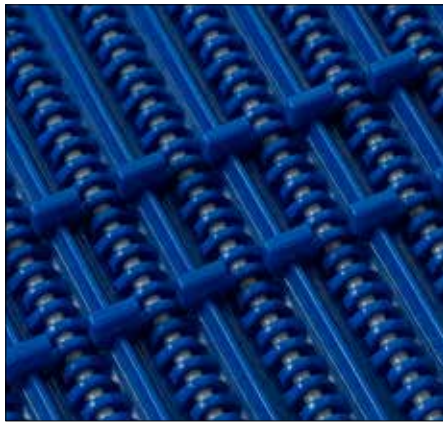

Type	Belt material & color	V		Z		A		B		Link size	Width	
		mm	in	mm	in	mm	in	mm	in		mm	in
Bottom Guide	POM-DI <b>W</b> PP <b>W B</b>	7.0	0.28	13.9	0.55	33.4	1.31	42.8	1.69	K725	184.2	7.25

Non Standard material and color: See uni Material and Color Overview.

## Accessories

### AmFlight

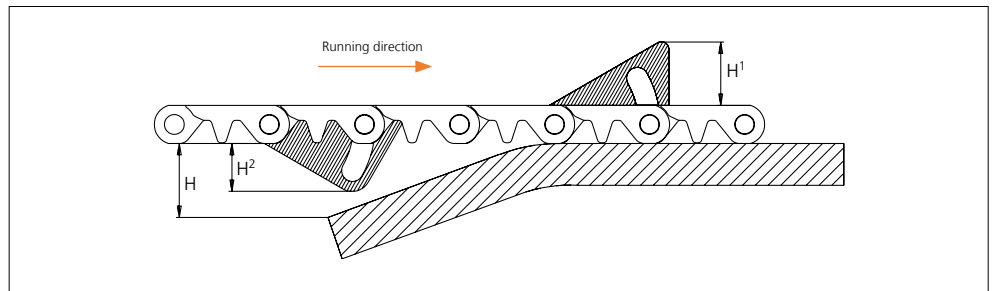
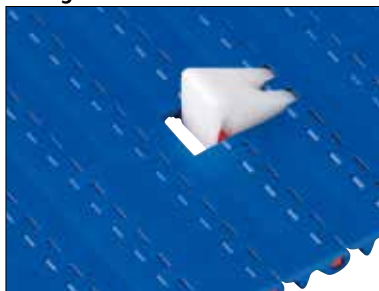

Type	Material & color	H		H <sup>1</sup>		H <sup>2</sup>	
		mm	in	mm	in	mm	in
Push	PE <b>W</b>	17.0	0.67	17.0	0.67	13.3	0.52

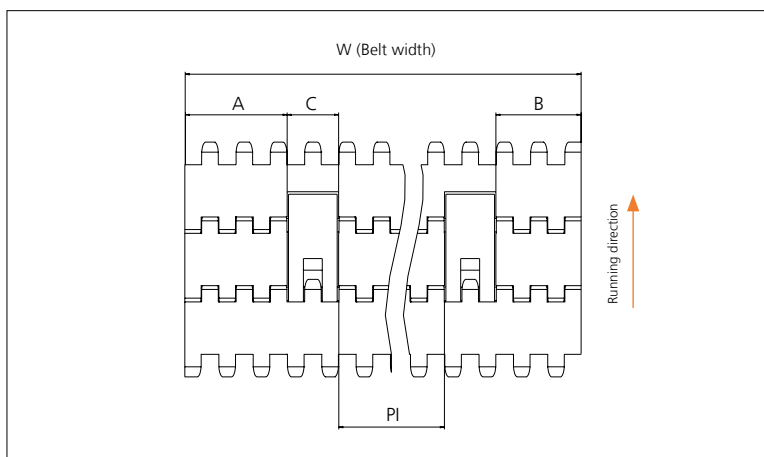

	mm	in
<b>A min</b>	38.4	1.51
<b>B min</b>	32.1	1.26
<b>C</b>	18.0	0.71
<b>PI max</b>	W - 106.5	W - 4.19
<b>PI min</b>	32.8	1.29

Increment: 12.7 mm (0.50 in).

## Sprocket

No. of teeth	Bore size									Overall diameter		Pitch-diameter		Hub-diameter		Dimension A		Dimension B		Double row/Two way	Molded PA6 LG	Machined PA6 N	
	Pilot bore																						
	mm	in	0.75	0.78	1.00	1.18	1.25	1.50	1.57	2.36	mm	in	mm	in	mm	in	mm	in					
Z06	✓		●	●							48.9	1.92	50.8	2.00	33.0	1.30	16.9	0.67	30,75	1.21	✓	✓	
Z08	✓				●	●	●				65.6	2.58	66.4	2.61	50.0	1.97	25.6	1.01	38,53	1.51	✓		✓
Z10	✓				●	●	●		●		82.2	3.23	82.2	3.24	66.0	2.60	34.0	1.34	46,44	1.82	✓	✓	
Z12	✓				●	●	●		●		98.6	3.88	98.1	3.86	70.0	2.76	42.3	1.67	54,42	2.14	✓	✓	
Z15	✓				●	●	●	■	●	■	123.1	4.84	122.2	4.81	100.0	3.94	54.54	2.15	66.43	2.62	✓	✓	
Z20	✓				●	●	●	■	●	■	163.8	6.44	162.4	6.39	100.0	3.94	75.08	2.96	86.53	3.41	✓	✓	

### Molded sprocket



### Machined sprocket

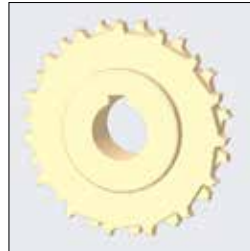

Other sprocket sizes are available upon request.  
 Other bore sizes on sprockets are available upon request.  
 Round bores are always delivered with keyway.  
 Max. load per sprocket shown does not take bore size into account.  
 Please also ensure that sufficient size shaft is chosen for corresponding load.

Width of tooth = Single row: 6.35 mm (0.25 in)  
 = Double row: 12.7 mm (0.50 in)

Width of One-part sprocket = Double row: 25.0 mm (0.98 in)

## uni UltraClean Two-Part Sprocket

No. of teeth	Bore size		Overall diameter		Pitch-diameter		Hub-diameter		Dimension A		Dimension B		Single row/One way	Moulded PA6 W
	in	1.57												
	mm	40.0	mm	in	mm	in	mm	in	mm	in	mm	in		
Z12		■	98.6	3.88	98.1	3.86	80.0	3.15	42.3	1.67	54.42	2.14	✓	✓
Z15		■	123.1	4.84	122.2	4.81	80.0	3.15	54.54	2.15	66.43	2.62	✓	✓
Z20		■	163.8	6.44	162.4	6.39	118.0	4.65	75.08	2.96	86.53	3.41	✓	✓

### Moulded uni UltraClean TwoPart Sprocket

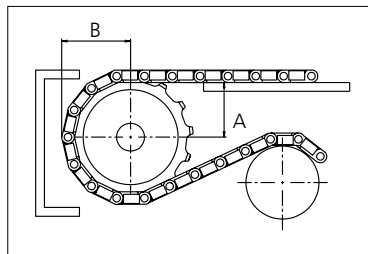

Width of UltraClean Two-part sprocket = Single row: 44.0 mm (1.73 in)  
 Width of UltraClean Two-part tooth = Single row: 6.35 mm (0.25 in)

uni Retainer Rings: See uni Retainer Ring data sheet.  
 For correct sprocket position: See uni Assembly Instructions for uni S-MPB.  
 For more detailed sprocket information, contact Customer Service.

uni S-MPB C/2019.12.10



Expert advice, quality solutions and local service for all your belting needs  
[www.ammeraalbeltech.com](http://www.ammeraalbeltech.com)

**Ammeraal Beltech Modular A/S**  
 Hjulmagervej 21  
 DK-7100 Vejle

T +45 7572 3100  
 F +45 7572 3348  
 admin@unichains.com  
 www.unichains.com

This information is subject to alteration due to continuous development. Ammeraal Beltech will not be held liable for the incorrect use of the above stated information. This information replaces previous information. All activities performed and services rendered by Ammeraal Beltech are subject to general terms and conditions of sale and delivery, as applied by its operating companies.