

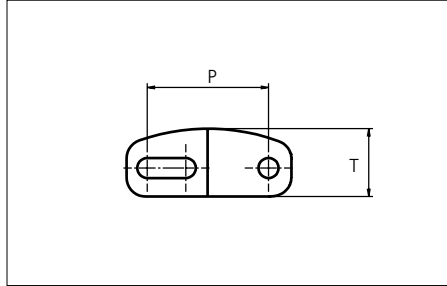

# Plastic Modular Belt

Series **uni Flex ASB** Type **43% Open Curved Surface (Radius 2.2)**

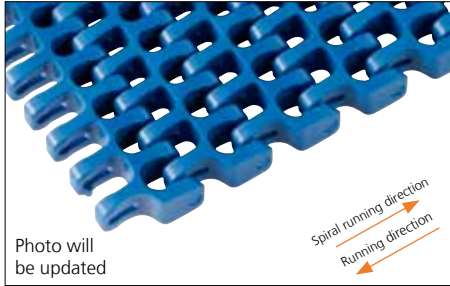

Sideflexing belt  
 Nominal pitch: 25.4 mm (1.00 in)  
 Surface type: Curved Surface  
 Surface opening: 43%  
 Backflex radius: 25.0 mm (0.98 in)  
 Pin diameter: 4.0 mm (0.16 in)  
 Min. inside radius: 2.2 x belt width

<b>Belt material &amp; color</b>	POM-D <b>W</b> <b>B</b>	<b>mm</b>	<b>in</b>
<b>Pin and lock material &amp; color</b>	PA6.6 <b>B</b>	<b>P (Nominal)</b>	25.4 / 1.00
		<b>T</b>	14.2 / 0.56

Non standard material and color: See uni Material and Color Overview.

Alternative pin and lock systems and materials: Contact Customer Service.

Belt width		Permissible tensile force (Belt/pin material)				Belt weight (Belt/pin material)		*Min. No. drive sprocket per shaft	Number of wear strips (Min. No.)	
		POM-D/PA6.6				POM-D/PA6.6			**Carry (pcs)	**Return (pcs)
		Straight sections		Curve sections		kg/m	lb/ft			
mm	in	N	lbf	N	lbf					
149	5.9	2801	630	1200	270	1.2	0.83	2	2	2
226	8.9	4249	955	1200	270	1.9	1.26	2	2	2
302	11.9	5678	1276	1200	270	2.5	1.68	3	3	2
379	14.9	7125	1602	1200	270	3.1	2.11	3	3	2
455	17.9	8554	1923	1200	270	3.8	2.54	5	4	2
531	20.9	9983	2244	1600	360	4.4	2.96	5	4	2
608	23.9	11430	2570	1600	360	5.0	3.39	5	5	3
684	26.9	12859	2891	2040	459	5.7	3.82	5	5	3
761	30.0	14307	3216	2040	459	6.3	4.24	7	6	3
837	33.0	15736	3537	2040	459	6.9	4.67	7	6	3
914	36.0	17183	3863	2040	459	7.6	5.10	7	7	4
990	39.0	18612	4184	2040	459	8.2	5.52	7	7	4

Additional standard belt widths are available in steps of 76.4 mm (3.01 in). Additional non-standard belt widths are available in steps of 12.7 mm (0.50 in).

1449	57.0	27241	6124	2040	459	11.9	7.99	11	10	5
------	------	-------	------	------	-----	------	------	----	----	---

Additional standard belt widths are available in steps of 76.4 mm (3.01 in). Additional non-standard belt widths are available in steps of 12.7 mm (0.50 in).

1984	78.1	37299	8385	2040	459	16.3	10.93	15	14	7
------	------	-------	------	------	-----	------	-------	----	----	---

General belt tolerance is +0/-0.4% at 23°C/73°F. For exact belt width contact Customer Service. Non standard belt width on request.

\*Max. Load per Drive Sprocket. Belt material: POM-D 2000 N (450 lbf).

\*\*Max. Spacing between wear strips, Carry: 152.0 mm (6.00 in); Return: 304.0 mm (12.00 in).

= Single Link



STANDARD

SIDE FLEXING

PITCH 25.4 MM/1.00 IN

**Accessories**

**Bottom Tab**

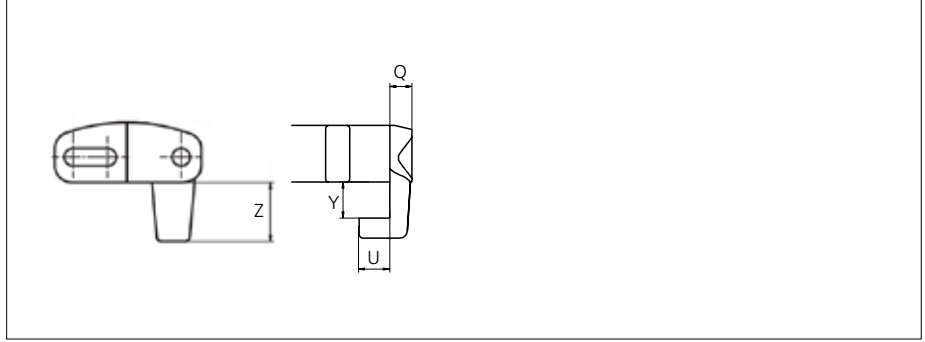
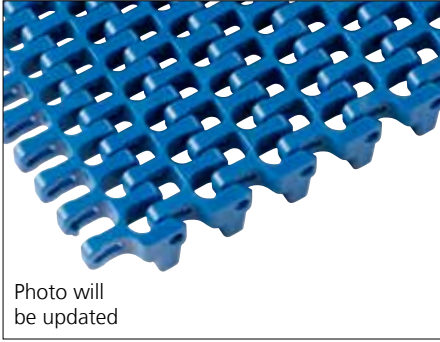

Type	Tab Material & color	Q		U		Y		Z	
		mm	in	mm	in	mm	in	mm	in
Bottom Tab	POM-D <b>B</b> <b>W</b>	5.5	0.22	7.5	0.30	9.0	0.35	14.0	0.55

Non Standard material and color: See uni Material and Color Overview.

**Design Guidelines**

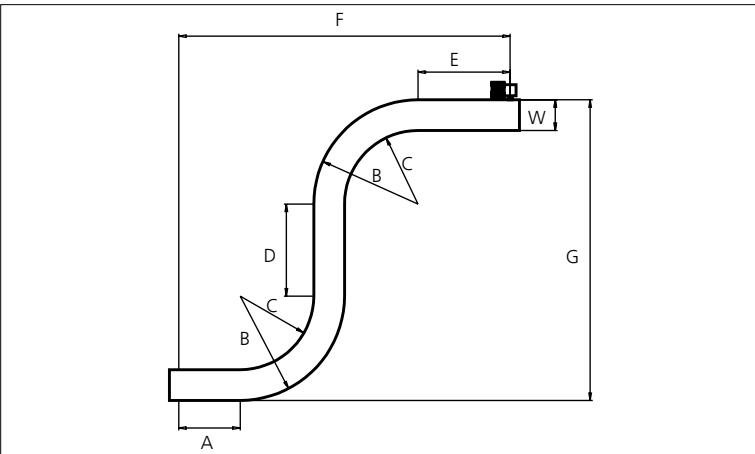

	uni Flex ASB Curved Surface R2.2
<b>A</b>	min. 1.5 x W
<b>B</b>	min. 3.2 x W
<b>C</b>	min. 2.2 x W
<b>D</b>	min. 2.0 x W
<b>E</b>	min. 2.0 x W
<b>F</b>	min. 8.9 x W
<b>G</b>	min. 8.4 x W

For min. conveyor dimensions please refer to sketch and diagram.

## Sprocket

No. of teeth	Bore size										Overall diameter		Pitch diameter		Hub diameter		Dimension A		Dimension B		Double row/Two way	Machined 
	Pilot Bore																					
	mm	in	0.79	0.98	1.00	1.18	1.25	1.50	1.57	2.36	mm	in	mm	in	mm	in	mm	in	mm	in		
Z07	✓		●	●	●						58.0	2.28	58.5	2.30	40.8	1.61	20.4	0.80	35.2	1.39	✓	✓
Z09	✓			●	●	●	●				75.0	2.95	74.3	2.93	57.8	2.28	28.9	1.14	43.1	1.70	✓	✓
Z12	✓			●	●	●	●	■			100.0	3.94	98.1	3.86	82.8	3.26	41.4	1.63	55.1	2.17	✓	✓
Z15	✓				●	●	●	■	●	■	124.6	4.91	122.2	4.81	107.4	4.23	53.8	2.12	67.1	2.64	✓	✓
Z18	✓					●	●	■	●	■	149.3	5.88	146.3	5.76	132.1	5.20	66.0	2.60	79.2	3.12	✓	✓

■ Machined sprocket

● Machined sprocket



Other sprocket sizes are available upon request.

Other bore sizes on sprockets are available upon request.

Round bores are always delivered with keyway.

Max. load per sprocket shown does not take bore size into account.

Please also ensure that sufficient size shaft is chosen for corresponding load.

Width of tooth = Single row + double row: 7.0 mm (0.28 in)

Width of One-part sprocket = Double row: 30.0 mm (1.18 in)

## uni UltraClean Two-Part Sprocket

No. of teeth	Bore size		Overall diameter		Pitch-diameter		Hub-diameter		Dimension A		Dimension B		Single row/Two way	Moulded 
	in	1.57												
	mm	40.0	mm	in	mm	in	mm	in	mm	in	mm	in		
Z12		■	100.0	3.94	98.1	3.86	80.0	3.15	41.4	1.63	55.1	2.17	✓	✓
Z15		■	124.6	4.91	122.2	4.81	80.0	3.15	53.8	2.12	67.1	2.64	✓	✓
Z18		■	149.3	5.88	146.3	5.76	80.0	3.15	66.0	2.60	79.2	3.12	✓	✓

■ Moulded uni UltraClean TwoPart Sprocket

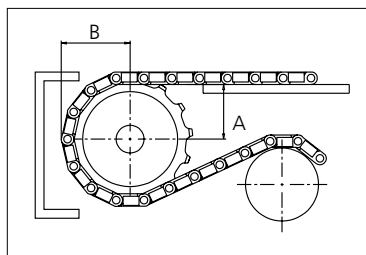

Width of UltraClean Two-part sprocket = Single row: 44.0 mm (1.73 in)

Width of UltraClean Two-part tooth = Single double row: 7.0 mm (0.28 in)

uni Retainer Rings: See uni Retainer Ring data sheet.

For correct sprocket position: See uni Assembly Instructions for uni Flex ASB.

For more detailed sprocket information, contact Customer Service.



Conveyor Belts



Seamless Belts



Modular Belts



Timing Belts

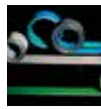

Transmission Belts



Fabrication & service

Expert advice, quality solutions  
and local service  
for all your belting needs  
[www.ammeraalbeltech.com](http://www.ammeraalbeltech.com)

**Ammeraal Beltech Modular A/S**  
Hjulmagervej 21  
DK-7100 Vejle

T +45 7572 3100  
F +45 7572 3348  
admin@unichains.com  
www.unichains.com

This information is subject to alteration due to continuous development. Ammeraal Beltech will not be held liable for the incorrect use of the above stated information. This information replaces previous information. All activities performed and services rendered by Ammeraal Beltech are subject to general terms and conditions of sale and delivery, as applied by its operating companies.